

**Bar faucets
 Robinetterie de bar
 Grifería para barras**

**KWC DOMO
 KWC TOPLINE
 KWC STAR
 KWC DORADO**

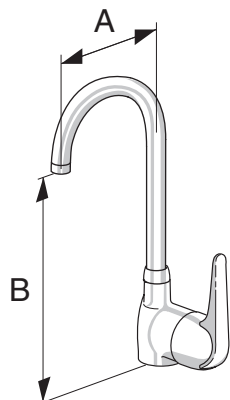

KWC DOMO
 K.10.61.U1 A=116mm / 4 1/2"
 B=295mm / 11 5/8"

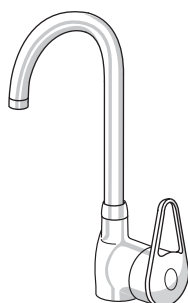

KWC TOPLINE
 K.10.B1.U1 A=116mm / 4 1/2"
 B=295mm / 11 5/8"

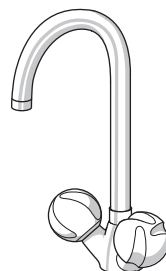

KWC STAR
 K.10.41.81 A=116mm / 4 1/2"
 B=240mm / 9 7/16"

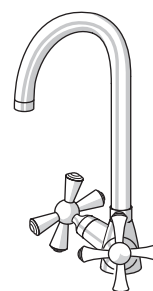

KWC DORADO
 K.10.X1.81 A=116mm / 4 1/2"
 B=240mm / 9 7/16"

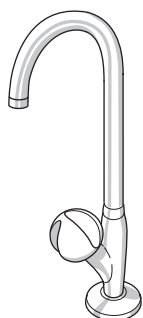

KWC STAR
 K.25.40.81 A=116mm / 4 1/2"
 B=275mm / 10 13/16"

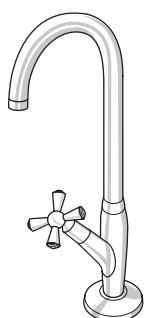

KWC DORADO
 25.X0.81 A=116mm / 4 1/2"
 B=275mm / 10 13/16"

E Operating data
 Ideal operating pressure : 3 bar (45 PSI)
 Max. operating pressure : 5 bar (70 PSI)
 Max. pressure difference cold/hot : 2 bar (25 PSI)
 Equal pressures are recommended.
 Ideal water temperature : 60 °C (140°F)
 Max. water temperature : 90 °C (194°F)

Attention:
 Before installation flush pipes thoroughly!

F Caractéristiques de fonctionnement
 Pression de service idéale : 3 bar (45 PSI)
 Pression de service max. : 5 bar (70 PSI)
 Différence de pression E./F./E.C. max. : 2 bar (25 PSI)
 Egalité de pression recommandée.
 Température idéale de l'eau : 60 °C (140°F)
 Température max. de l'eau : 90 °C (194°F)

Attention:
 Rincer à fond la tuyauterie avant le montage!

SP Datos de servicio
 Presión ideal de servicio : 3 bar (45 PSI)
 Presión máxima de servicio : 5 bar (70 PSI)
 Diferencia máxima de presión fría / caliente : 2 bar (25 PSI)
 Se recomienda la igualdad de las presiones.
 Temperatura ideal del agua : 60 °C (140°F)
 Temperatura máxima del agua : 90 °C (194°F)

Atención:
 Enjuagar escrupulosamente las tuberías antes del montaje!

Installation / Taking into service **1**
Montage / Mise en Service
Montaje / Puesta en servicio

Limitation of flow rate (mixer only) **2**
Limitation du débit (mitigeur seulement)
Limitación del caudal (solamente mezclador)

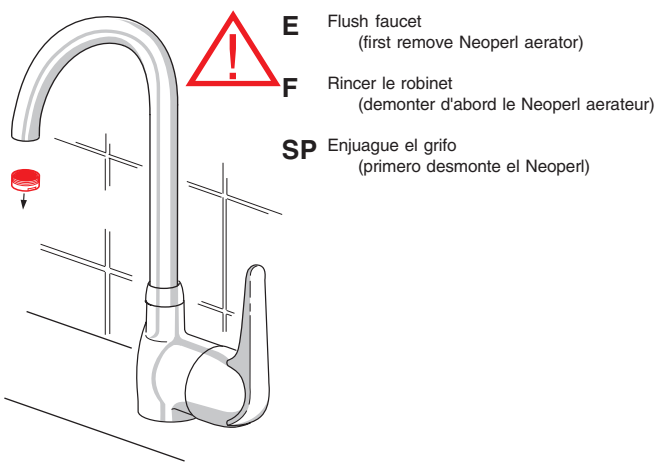
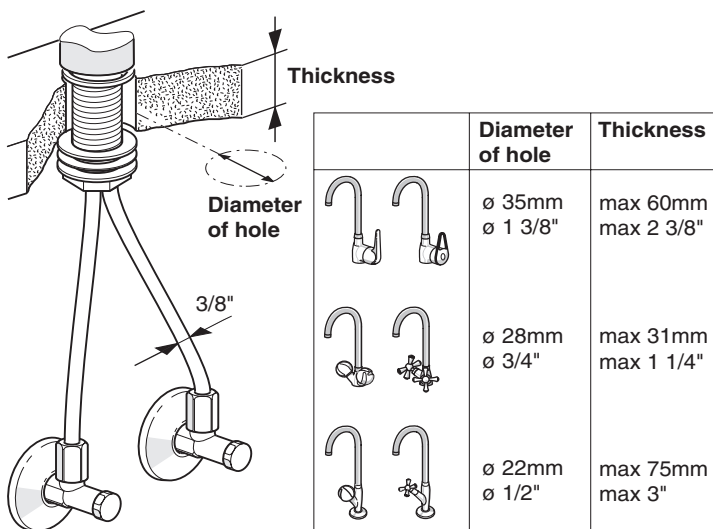

KWC DOMO

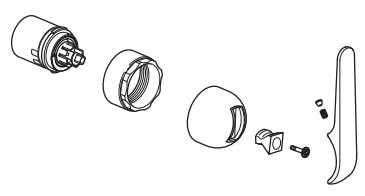
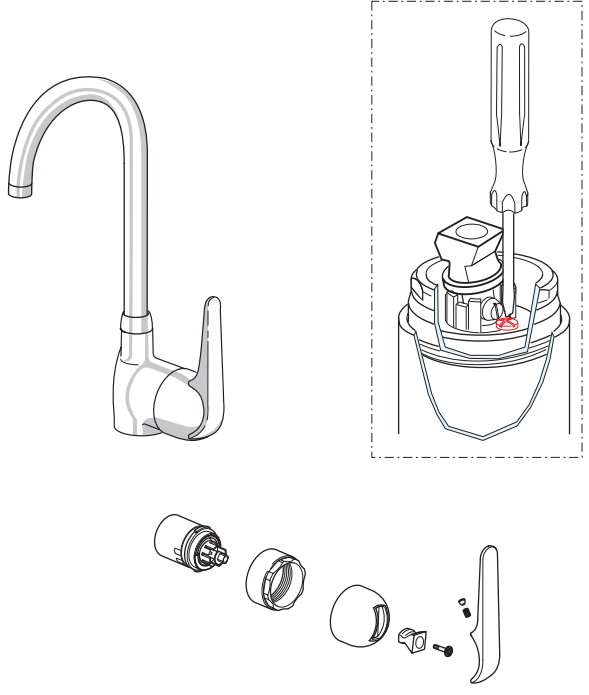

KWC TOPLINE

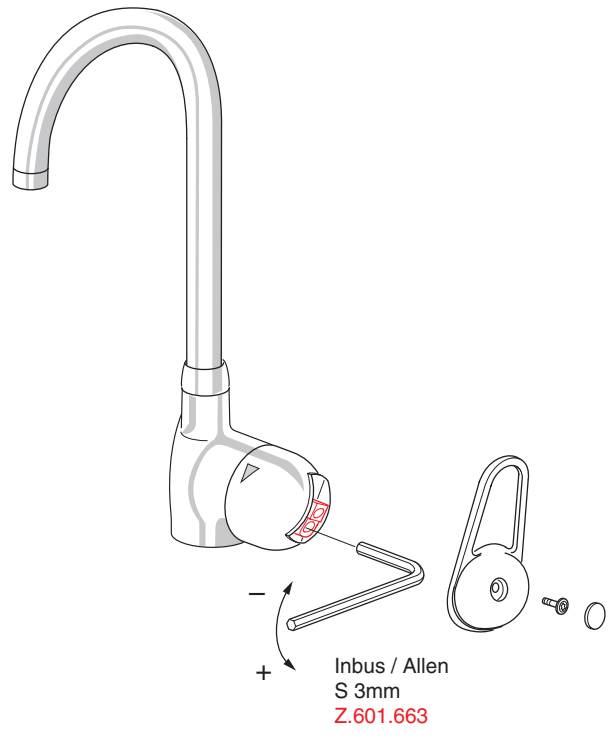

**Escutcheon
Rosace
Roseta**

Z.504.806 length: 262mm / 10"
Z.504.807 length: 160mm / 6"

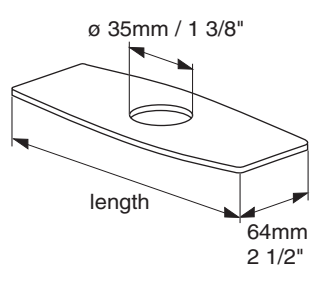

**Faucet hole cover
Couvercle pour trou de rob.
Placa de cubierta**

Z.504.093

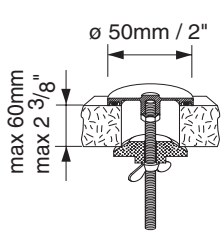

Temperature Limitation
Limitation de la température max.
Limitación de la temperatura máxima

3

Replacing the control cartridge
Remplacement de la cartouche
Recambio del cartucho de mando

4

mixer only
mitigeur seulement
solamente mezclador

KWC DOMO

Limitator ring (yellow)
 L'anneau de limitation (jaune)
 Anillo de limitación (amarillo)

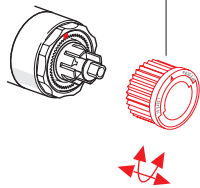

KWC TOPLINE



Torx 20 / No 4

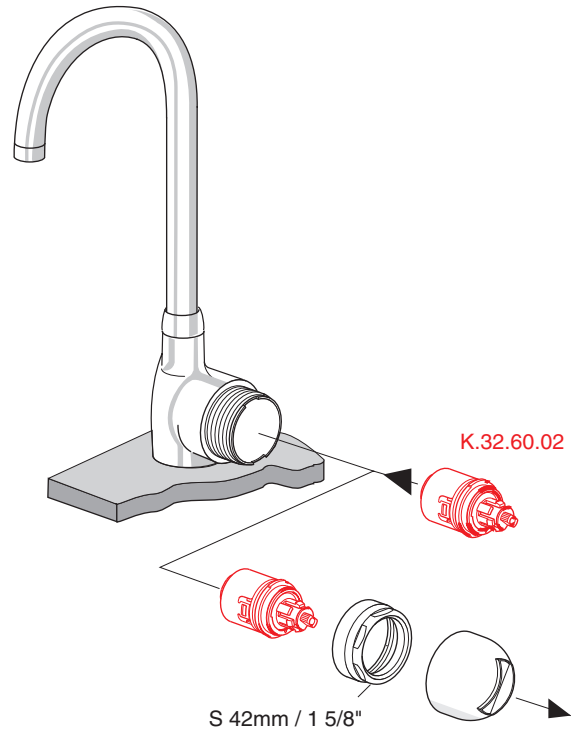

K.32.60.02

S 42mm / 1 5/8"

Max. temperature range
Plage de température max.
Gama de temperaturas máx.

Reduced temperature range
Plage de température réduite
Gama de temperaturas reducidas

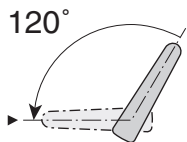
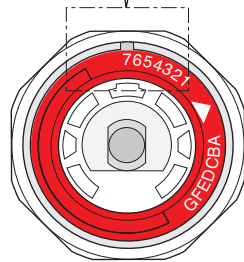
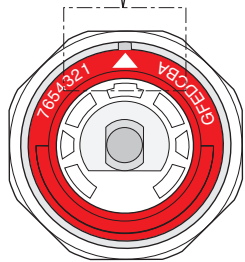
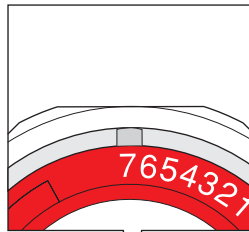
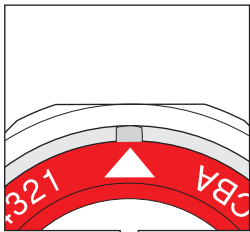

Arrow on groove
 Flèche sur encroche
 Flecha en la hendidura

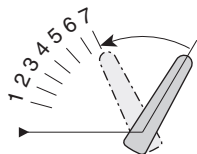

Positions 1 - 7
 Position 1 - 7
 Posición 1 - 7

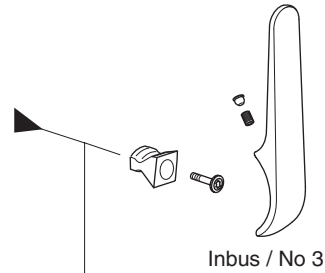

Inbus / No 3

KWC DOMO

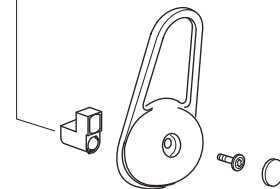

Torx 20 / No 4

KWC TOPLINE

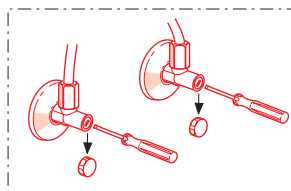

Turn off cold and hot water
 Fermer eau froide et chaude
 Interrumpir la salida de agua fría y caliente

Spare parts
Pièces de rechange
Repuestos

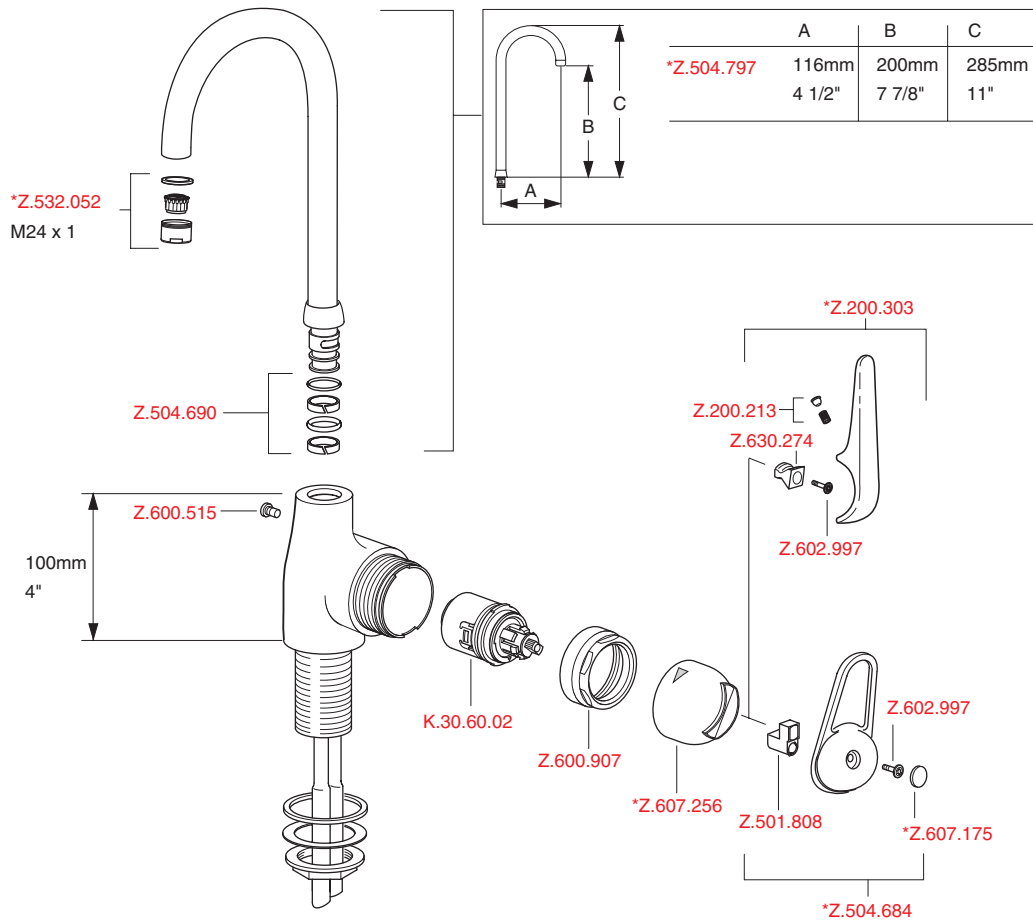

KWC DOMO

KWC TOPLINE

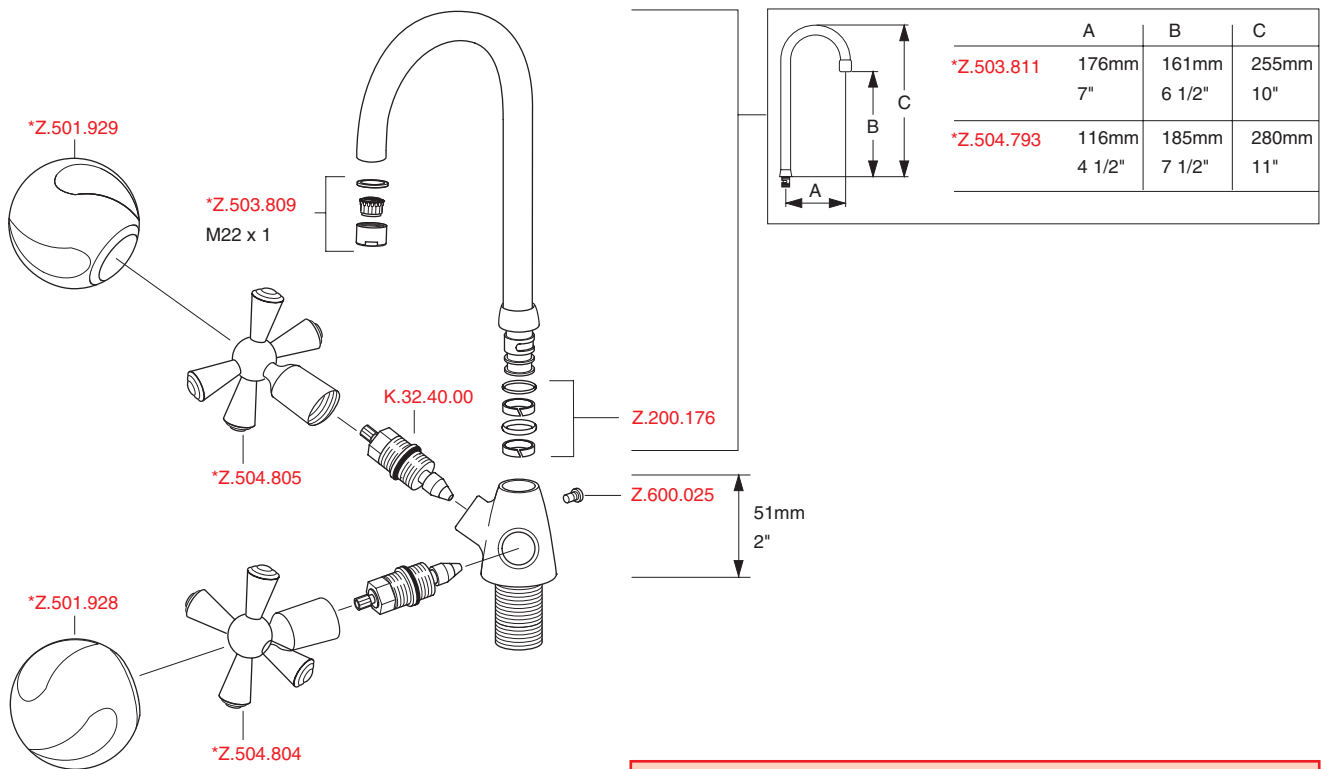

KWC STAR

KWC DORADO

E * Please specify the color when placing your order.
F * Lors de la commande, veuillez indiquer la couleur, s.v.p.
Sp * Rogamos indicar el color al hacer el pedido.